



Figure can vary

Part no.: 50134100
DCR 202i FIX-M1-102-R3-G-V
Stationary 2D-code reader



RS232

RS422

Ethernet



Contents

- Technical data
- Dimensioned drawings
- Electrical connection
- Diagrams
- Operation and display
- Accessories
- Notes



Technical data

Basic data	
Series	DCR 200i
Functions	
Software functions	Reading of 1D codes Reading of 2D codes
Read data	
Code types, readable	QR code Code 39 EAN 8/13 GS1 Databar GS1 Databar Stacked Code 128 Aztec Codabar Code 93 Data Matrix Code PDF417 GS1 Databar QR code EAN 128 UPC Pharma Code 2/5 Interleaved GS1 Databar Omnidirectional Code 32
Optical data	
Reading distance	50 ... 220 mm
Light source	LED, Red
Transmitted-signal shape	Pulsed
Camera resolution, horizontal	1,280 px
Camera resolution, vertical	960 px
Chip	CMOS
Module size	0.19 ... 0.5 mm
Electronic shutter speed	0.068 ... 5 ms
Camera type	Monochrome
Electrical data	
Protective circuit	Short circuit protected Polarity reversal protection
Performance data	
Supply voltage	18 ... 30 V, DC
Average power consumption	8 W
Inputs	
Number of digital switching inputs	1 Piece(s)
Switching inputs	
Type	Digital switching input
Voltage type	DC

Outputs

Number of digital switching outputs 1 Piece(s)

Switching outputs

Type Digital switching output

Voltage type DC

Switching current, max. 100 mA

Switching output 1

Switching element Transistor,

Switching principle +24 V switching

Inputs/outputs selectable

Number of inputs/outputs selectable 2 Piece(s)

Type Inputs/outputs selectable

Voltage type DC

Voltage type DC

Interface

Type RS 232, RS 422, Ethernet

RS 232

Function Process

Transmission speed 4,800 ... 115,200 Bd

Data format Adjustable

Start bit 1

Data bit 8 data bits

Stop bit 1 stop bit

Parity None

Transmission protocol <STX><data><CR><LF>

Data encoding Binary
ASCII

RS 422

Function Process

Transmission speed 4,800 ... 115,200 Bd

Data format Adjustable

Start bit 1

Data bit 7, 8 data bits

Stop bit 1, 2 stop bits

Data encoding Binary
ASCII

Ethernet

Architecture Client
Server

Address assignment DHCP
Manual address assignment

Transmission speed 100 Mbit/s
10 Mbit/s

Function Process

Switch functionality None

Transmission protocol TCP/IP , UDP

Service interface

Type Ethernet

Part no.: 50134100 – DCR 202i FIX-M1-102-R3-G-V – Stationary 2D-code
Ethernet

Function	Service
----------	---------

Connection

Number of connections	2 Piece(s)
-----------------------	------------

Connection 1

Type of connection	Connector
Function	Voltage supply Data interface Signal OUT Signal IN
Thread size	M12
Type	Male
Material	Stainless steel
No. of pins	12 -pin
Encoding	A-coded

Connection 2

Type of connection	Connector
Function	Data interface Configuration interface
Thread size	M12
Type	Female
Material	Stainless steel
No. of pins	4 -pin
Encoding	D-coded

Mechanical data

Design	Cubic
Dimension (W x H x L)	46 mm x 61 mm x 46 mm
Housing material	Stainless steel, V4A
Lens cover material	Glass
Net weight	392 g
Housing color	Silver
Type of fastening	Via optional mounting device Mounting thread
Compatibility of materials	ECOLAB

Operation and display

Type of display	LED
Number of LEDs	3 Piece(s)
Type of configuration	Via web browser Configuration codes Teach-in

Environmental data

Ambient temperature, operation	0 ... 50 °C
Ambient temperature, storage	-20 ... 70 °C
Relative humidity (non-condensing)	90 %

Certifications

Degree of protection	IP 69K IP 67
----------------------	-----------------

Protection class	III
Certifications	c UL US
Test procedure for EMC in accordance with standard	EN 61000-6-4 EN 61000-6-2
Test procedure for continuous shock in accordance with standard	IEC 60068-2-29, test Eb
Test procedure for vibration in accordance with standard	IEC 60068-2-6, test Fc

Classification	
eCl@ss 8.0	27280103
eCl@ss 9.0	27280103
ETIM 5.0	EC002550

Dimensioned drawings

All dimensions in millimeters

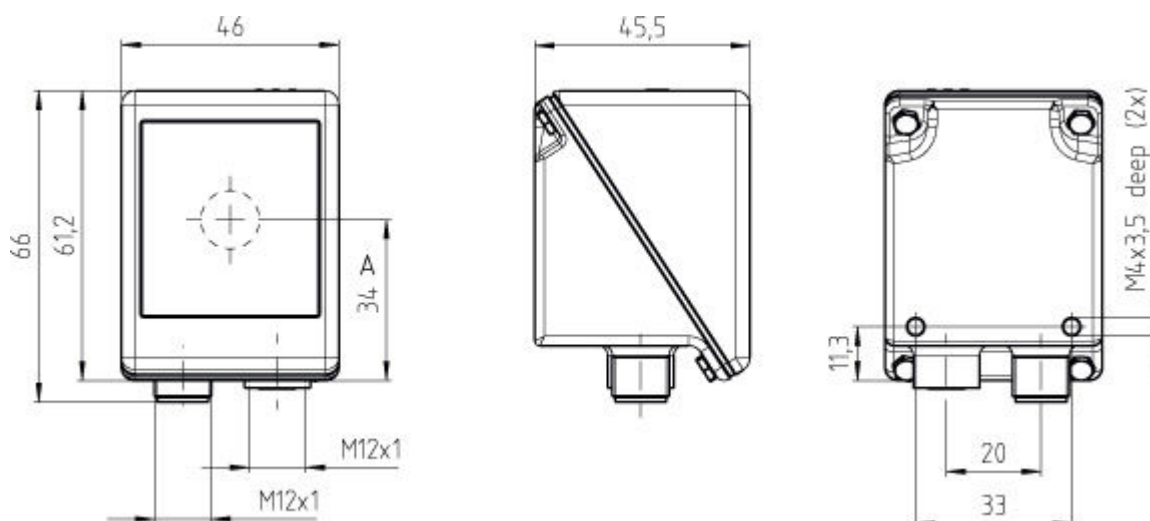

Electrical connection

Connection 1	PWR / SWIO
Type of connection	Connector
Function	Voltage supply Data interface Signal OUT Signal IN
Thread size	M12
Type	Male
Material	Stainless steel
No. of pins	12 -pin
Encoding	A-coded

Part no.: 50134100 – DCR 202i FIX-M1-102-R3-G-V – Stationary 2D-code

Pin	Pin assignment
1	VIN
2	GNDIN
3	SWIN 1
4	SWOUT 2
5	FE
6	GND RS 232 / GND RS 422
7	Rx-
8	Tx-
9	RxD/Rx+
10	TxD/Tx+
11	SWIO 3
12	SWIO 4

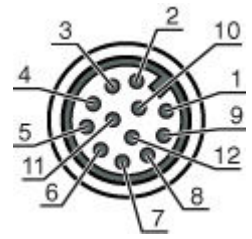

Connection 2	HOST
Type of connection	Connector
Function	Data interface Configuration interface
Thread size	M12
Type	Female
Material	Stainless steel
No. of pins	4 -pin
Encoding	D-coded

Pin	Pin assignment
1	TD+
2	RD+
3	TD-
4	RD-

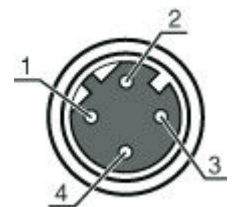

Diagrams

Reading distances

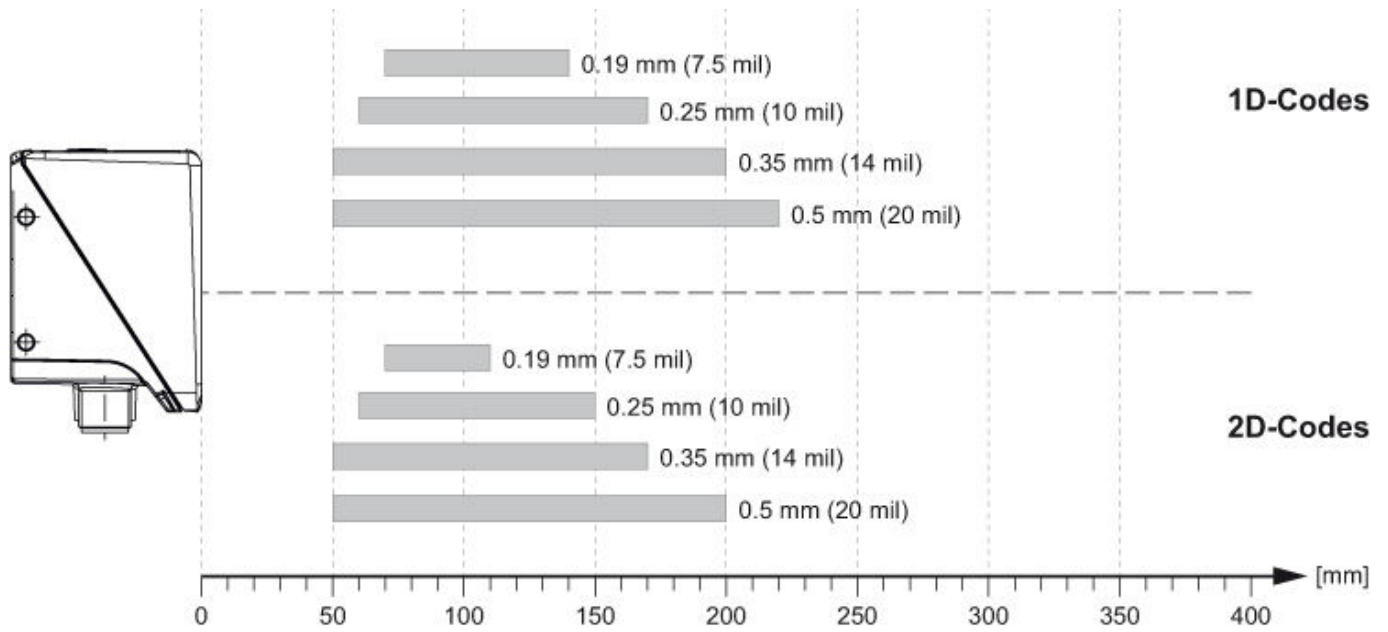

Relationship between camera distance and reading field size

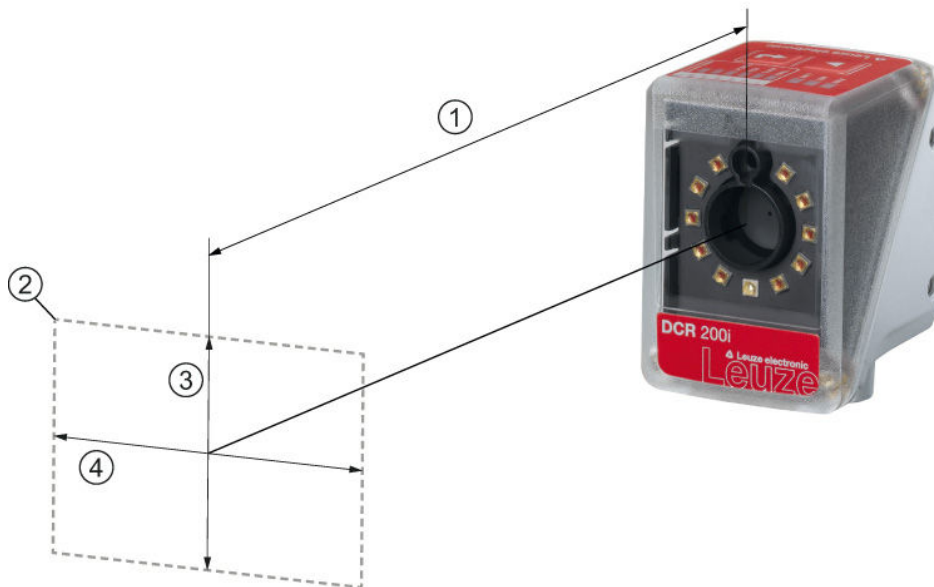

- 1 Camera distance
- 2 Reading field
- 3 Reading field height [mm]
- 4 Reading field width [mm]

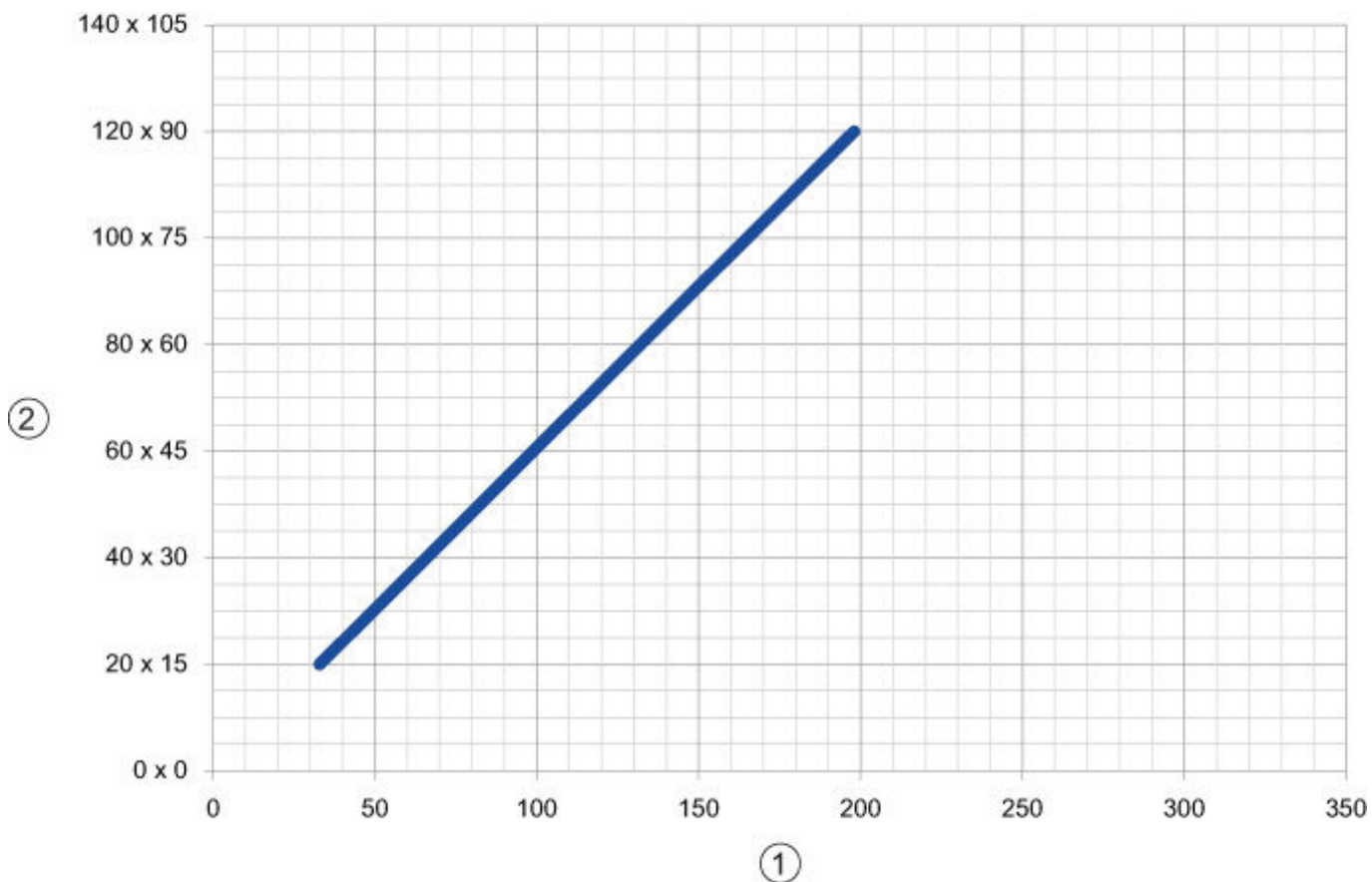

- 1 Camera distance [mm]
- 2 Reading field: width x height [mm]







Operation and display

LEDs

LED	Display	Meaning	
1	PWR	Off	No supply voltage
		Green, flashing	Initialization
		Green, continuous light	Operational readiness
		Orange, continuous light	Service operation
		Red, flashing	Device OK, warning set
		Red, continuous light	Device error
2	NET	Off	No supply voltage
		Green, flashing	Initialization
		Green, continuous light	Operational readiness
		Red, flashing	Communication error
		Red, continuous light	Network error
3	LINK	Green, continuous light	Ethernet connection is established
		Yellow, flashing	Data exchange active

Accessories







Connection technology - Connection unit

	Part no.	Designation	Article	Description
	50130109	MA 150	Modular connection unit	Supply voltage: 18 ... 30 V Current consumption, max.: 150 mA Connections: 5 Piece(s) Degree of protection: IP 67
	50112893	MA 204i Profibus Gateway	Modular connection unit	Supply voltage: 18 ... 30 V Current consumption, max.: 300 mA Interface: PROFIBUS DP, RS 232 Connections: 6 Piece(s) Degree of protection: IP 65
	50114154	MA 235i CANopen Gateway	Modular connection unit	Supply voltage: 18 ... 30 V Current consumption, max.: 300 mA Interface: CANopen, RS 232 Connections: 6 Piece(s) Degree of protection: IP 65
	50114155	MA 238i EtherCAT Gateway	Modular connection unit	Supply voltage: 18 ... 30 V Current consumption, max.: 300 mA Interface: EtherCAT, RS 232 Connections: 6 Piece(s) Degree of protection: IP 65
	50112891	MA 248i Profinet Gateway	Modular connection unit	Supply voltage: 18 ... 30 V Current consumption, max.: 300 mA Interface: PROFINET, RS 232 Connections: 6 Piece(s) Degree of protection: IP 65
	50114156	MA 255i DeviceNet Gateway	Modular connection unit	Supply voltage: 18 ... 30 V Current consumption, max.: 300 mA Interface: RS 232, DeviceNet Connections: 6 Piece(s) Degree of protection: IP 67
	50114157	MA 258i EtherNet/IP Gateway	Modular connection unit	Supply voltage: 18 ... 30 V Current consumption, max.: 300 mA Interface: EtherNet IP, RS 232 Connections: 6 Piece(s) Degree of protection: IP 65

Connection technology - Connection cables

	Part no.	Designation	Article	Description
	50130281	KD S-M12-CA-P1-020	Connection cable	Connection 1: Connector, M12, Axial, Female, A-coded, 12 -pin Connection 2: Open end Shielded: Yes Cable length: 2,000 mm Sheathing material: PUR

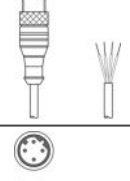
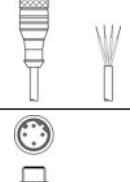
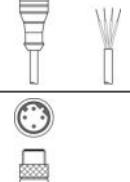
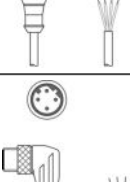
Part no.: 50134100 – DCR 202i FIX-M1-102-R3-G-V – Stationary 2D-code

	Part no.	Designation	Article	Description
	50130282	KD S-M12-CA-P1-050	Connection cable	Connection 1: Connector, M12, Axial, Female, A-coded, 12 -pin Connection 2: Open end Shielded: Yes Cable length: 5,000 mm Sheathing material: PUR
	50130283	KD S-M12-CA-P1-100	Connection cable	Connection 1: Connector, M12, Axial, Female, A-coded, 12 -pin Connection 2: Open end Shielded: Yes Cable length: 10,000 mm Sheathing material: PUR
	50134943	KD S-M12-CW-P1-050	Connection cable	Connection 1: Connector, M12, Angled, Female, A-coded, 12 -pin Connection 2: Open end Shielded: Yes Cable length: 5,000 mm Sheathing material: PUR
	50135073	KS ET-M12-4A-P7-020	Connection cable	Suitable for interface: Ethernet Connection 1: Connector, M12, Axial, Male, D-coded, 4 -pin Connection 2: Open end Shielded: Yes Cable length: 2,000 mm Sheathing material: PUR
	50135074	KS ET-M12-4A-P7-050	Connection cable	Suitable for interface: Ethernet Connection 1: Connector, M12, Axial, Male, D-coded, 4 -pin Connection 2: Open end Shielded: Yes Cable length: 5,000 mm Sheathing material: PUR
	50135075	KS ET-M12-4A-P7-100	Connection cable	Suitable for interface: Ethernet Connection 1: Connector, M12, Axial, Male, D-coded, 4 -pin Connection 2: Open end Shielded: Yes Cable length: 10,000 mm Sheathing material: PUR
	50135076	KS ET-M12-4A-P7-150	Connection cable	Suitable for interface: Ethernet Connection 1: Connector, M12, Axial, Male, D-coded, 4 -pin Connection 2: Open end Shielded: Yes Cable length: 15,000 mm Sheathing material: PUR
	50135077	KS ET-M12-4A-P7-300	Connection cable	Suitable for interface: Ethernet Connection 1: Connector, M12, Axial, Male, D-coded, 4 -pin Connection 2: Open end Shielded: Yes Cable length: 30,000 mm Sheathing material: PUR
	50134942	KS ET-M12-4W-P7-050	Connection cable	Suitable for interface: Ethernet Connection 1: Connector, M12, Angled, Male, D-coded, 4 -pin Connection 2: Open end Shielded: Yes Cable length: 5,000 mm Sheathing material: PUR



Connection technology - Interconnection cables

	Part no.	Designation	Article	Description
	50106905	KB ET-30000-SSA	Interconnection cable	Suitable for interface: Ethernet Connection 1: Connector, M12, Axial, Male, D-coded, 4 -pin Connection 2: Connector, M12, Axial, Male, D-coded, 4 -pin Shielded: Yes Cable length: 30,000 mm Sheathing material: PUR
	50132488	KB JST- M12A-12P-50	Interconnection cable	
	50137694	KDS S-M12-CA- M12-5A- P1-004-23X	Interconnection cable	Connection 1: Connector, M12, Axial, Female, A-coded, 12 -pin Connection 2: Connector, M12, Axial, Male, A-coded, 5 -pin Shielded: Yes Cable, crossed: Connection 1, pin 2 <-> connection 2, pin 3 Cable length: 400 mm Sheathing material: PUR
	50130284	KDS S-M12-CA- M12-CA-P1-020	Interconnection cable	Connection 1: Connector, M12, Axial, Female, A-coded, 12 -pin Connection 2: Connector, M12, Axial, Male, A-coded, 12 -pin Shielded: Yes Cable length: 2,000 mm Sheathing material: PUR
	50130285	KDS S-M12-CA- M12-CA-P1-050	Interconnection cable	Connection 1: Connector, M12, Axial, Female, A-coded, 12 -pin Connection 2: Connector, M12, Axial, Male, A-coded, 12 -pin Shielded: Yes Cable length: 5,000 mm Sheathing material: PUR
	50130286	KDS S-M12-CA- M12-CA-P1-100	Interconnection cable	Connection 1: Connector, M12, Axial, Female, A-coded, 12 -pin Connection 2: Connector, M12, Axial, Male, A-coded, 12 -pin Shielded: Yes Cable length: 10,000 mm Sheathing material: PUR
	50137077	KSS ET-M12-4A- M12-4A-P7-020	Interconnection cable	Suitable for interface: Ethernet Connection 1: Connector, M12, Axial, Male, D-coded, 4 -pin Connection 2: Connector, M12, Axial, Male, D-coded, 4 -pin Shielded: Yes Cable length: 1,000 mm Sheathing material: PUR
	50137078	KSS ET-M12-4A- M12-4A-P7-050	Interconnection cable	Suitable for interface: Ethernet Connection 1: Connector, M12, Axial, Male, D-coded, 4 -pin Connection 2: Connector, M12, Axial, Male, D-coded, 4 -pin Shielded: Yes Cable length: 1,000 mm Sheathing material: PUR
	50137079	KSS ET-M12-4A- M12-4A-P7-100	Interconnection cable	Suitable for interface: Ethernet Connection 1: Connector, M12, Axial, Male, D-coded, 4 -pin Connection 2: Connector, M12, Axial, Male, D-coded, 4 -pin Shielded: Yes Cable length: 10,000 mm Sheathing material: PUR
	50137080	KSS ET-M12-4A- M12-4A-P7-150	Interconnection cable	Suitable for interface: Ethernet Connection 1: Connector, M12, Axial, Male, D-coded, 4 -pin Connection 2: Connector, M12, Axial, Male, D-coded, 4 -pin Shielded: Yes Cable length: 15,000 mm Sheathing material: PUR

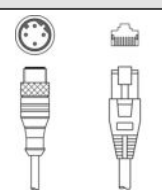
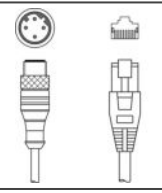
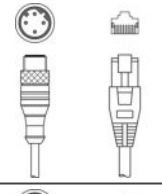
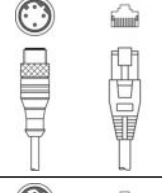
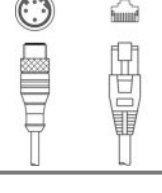
Part no.: 50134100 – DCR 202i FIX-M1-102-R3-G-V – Stationary 2D-code

	Part no.	Designation	Article	Description
	50135080	KSS ET-M12-4A-RJ45-A-P7-020	Interconnection cable	Suitable for interface: Ethernet Connection 1: Connector, M12, Axial, Male, D-coded, 4 -pin Connection 2: RJ45 Shielded: Yes Cable, crossed: Connection 1, pin 2 <-> connection 2, pin 3 Cable length: 2,000 mm Sheathing material: PUR
	50135081	KSS ET-M12-4A-RJ45-A-P7-050	Interconnection cable	Suitable for interface: Ethernet Connection 1: Connector, M12, Axial, Male, D-coded, 4 -pin Connection 2: RJ45 Shielded: Yes Cable, crossed: Connection 1, pin 2 <-> connection 2, pin 3 Cable length: 5,000 mm Sheathing material: PUR
	50135082	KSS ET-M12-4A-RJ45-A-P7-100	Interconnection cable	Suitable for interface: Ethernet Connection 1: Connector, M12, Axial, Male, D-coded, 4 -pin Connection 2: RJ45 Shielded: Yes Cable, crossed: Connection 1, pin 2 <-> connection 2, pin 3 Cable length: 10,000 mm Sheathing material: PUR
	50135083	KSS ET-M12-4A-RJ45-A-P7-150	Interconnection cable	Suitable for interface: Ethernet Connection 1: Connector, M12, Axial, Male, D-coded, 4 -pin Connection 2: RJ45 Shielded: Yes Cable, crossed: Connection 1, pin 2 <-> connection 2, pin 3 Cable length: 15,000 mm Sheathing material: PUR
	50135084	KSS ET-M12-4A-RJ45-A-P7-300	Interconnection cable	Suitable for interface: Ethernet Connection 1: Connector, M12, Axial, Male, D-coded, 4 -pin Connection 2: RJ45 Shielded: Yes Cable, crossed: Connection 1, pin 2 <-> connection 2, pin 3 Cable length: 30,000 mm Sheathing material: PUR

Connection technology - Connectors

	Part no.	Designation	Article	Description
	50132254	D M12A-12P	Connector	Connection: Connector with solder connection, M12, Axial, Female, A-coded, 12 -pin
	50112155	S-M12A-ET	Connector	Suitable for interface: Ethernet Connection: Connector, M12, Axial, Male, D-coded, 4 -pin

Connection technology - Adapters

	Part no.	Designation	Article	Description
	50132255	D M12A-12P-PWR	Adapter	Number of connections: 2 Piece(s) Connection 1: Connector, M12, Axial, Female, A-coded, 12 -pin Connection 2: Jack socket

Part no.: 50134100 – DCR 202i FIX-M1-102-R3-G-V – Stationary 2D-code

Mounting technology - Mounting brackets

	Part no.	Designation	Article	Description
	50132151	BT 320M	Mounting bracket	Design of mounting device: Angle, L-shape Mounting bracket, at system: Through-hole mounting Mounting bracket, at device: Screw type Type of mounting device: Rigid Material: Metal

Mounting technology - Rod mounts

	Part no.	Designation	Article	Description
	50132150	BTU 320M-D12	Mounting system	Contains: 4x M4 x 6 screws Design of mounting device: Mounting system Mounting bracket, at system: For 12 mm rod Mounting bracket, at device: Screw type Type of mounting device: Clampable, Adjustable, Turning, 360° Material: Metal

Notes

Observe intended use!
<ul style="list-style-type: none"> • This product is not a safety sensor and is not intended as personnel protection. • The product may only be put into operation by competent persons. • Only use the product in accordance with its intended use.